

GJD D-TECT Laser User Manual

LASER SCANNERS FOR BUILDING AUTOMATION AND SECURITY

GJD509 : max. detection range of 10m x 10m

GJD505 : max. detection range of 5.0m x 5.0m

SAFETY

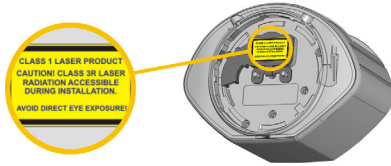

The device contains IR and visible laser diodes.
IR laser: wavelength 905nm; max. output pulse power 75W (Class 1 according to IEC 60825-1)
Visible laser: wavelength 650nm; max. output CW power 3mW (Class 3R according to IEC 60825-1)

The visible laser beams are inactive during normal functioning.
The installer can activate the visible lasers if needed.



CAUTION!

Use of controls, adjustments or performance of procedures other than those specified herein may result in hazardous radiation exposure.

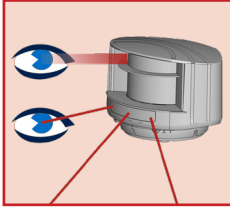

Do not look into the laser emitter or the visible red laser beams.

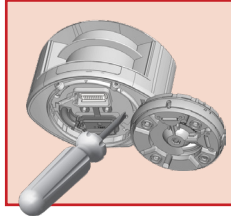

The warranty is void if unauthorized repairs are made or attempted by unauthorized personnel.



Only trained and qualified personnel may install and adjust the sensor.



Test the good functioning of the installation before leaving the premises.

The manufacturer of the door system is responsible for carrying out a risk assessment and installing the sensor and the door system in compliance with applicable national and international regulations and standards on door safety and if applicable, the machinery directive 2006/42/EC. Other use of the device is outside the permitted purpose and can not be guaranteed by the manufacturer. The manufacturer cannot be held responsible for incorrect installations or inappropriate adjustments of the sensor.

INSTALLATION AND MAINTENANCE

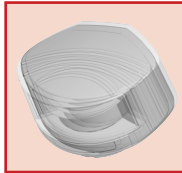

Avoid extreme vibrations.

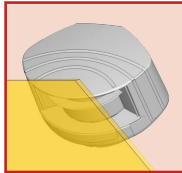

Do not cover the front screens.

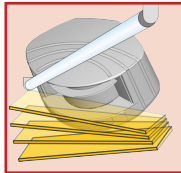

Avoid moving objects and light sources in the detection field.

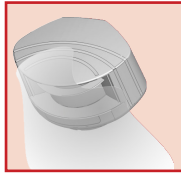

Avoid the presence of smoke and fog in the detection field.

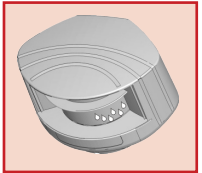

Avoid condensation.

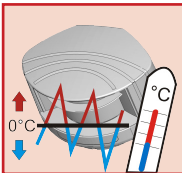

Avoid exposure to sudden and extreme temperature changes.

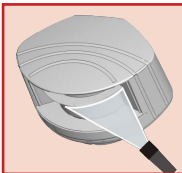

Avoid direct exposure to high pressure cleaning.



Do not use aggressive products to clean the front screens.

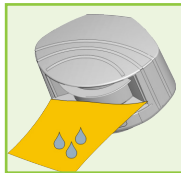

Wipe the front screens regularly with a clean and damp cloth.

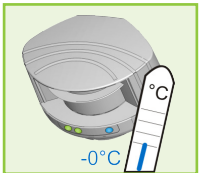

Keep the sensor permanently powered in environments where the temperature can descend below -10°C.

DESCRIPTION

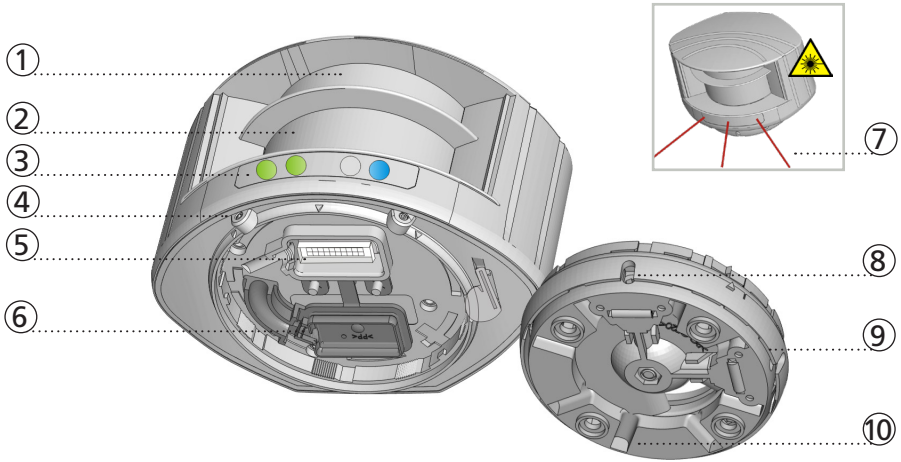

- | | |
|--------------------------------|--|
| 1. laser sweep emission | 6. protection cover |
| 2. laser sweep reception | 7. visible laser beam (3) |
| 3. LED-signal (4) | 8. notch for tilt angle adjustment (2) |
| 4. screw for position lock (2) | 9. adjustable bracket |
| 5. connector | 10. cable conduit (4) |

LED-SIGNAL

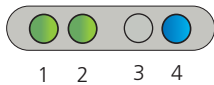

1. Detection LED: relay 1 - optional field
2. Detection LED: relay 2 - safety field
3. Error LED
4. Power LED

DETECTION LEDs

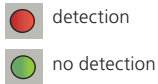

ERROR LED



POWER LED

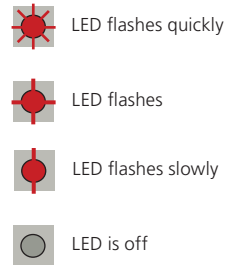

TIP! All LEDs can be switched off and on again by remote control:



SYMBOLS



Caution!
Laser radiation

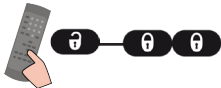

Remote control
sequence



Possible
remote control
adjustments



Factory
values



According
to



Not
according
to

EN ISO 13849-1:2008
PI «d» / CAT2

1 MOUNTING

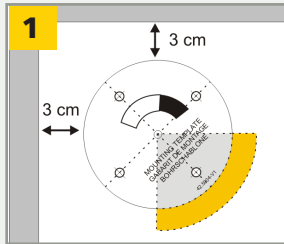
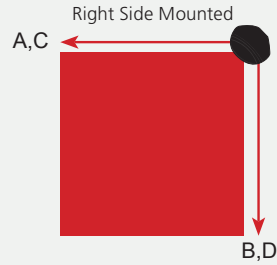
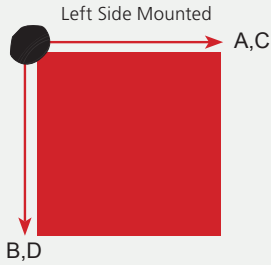

Use the adhesive mounting template to position the sensor correctly. The grey area indicates the detection range.

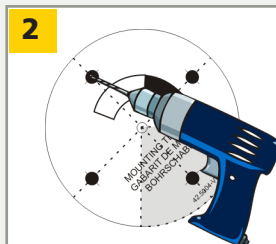

Drill 4 holes as indicated on the mounting template. Make a hole for the cable if possible.

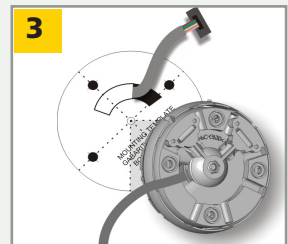

Pass the cable +/- 10 cm through the cable opening. If drilling an opening is not possible, use the cable conduits on the back side of the bracket.

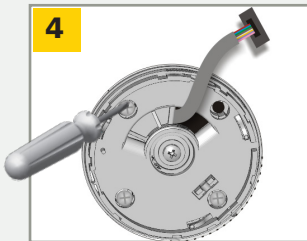

Position the bracket and fasten the 4 screws firmly in order to avoid vibrations.



Open the protection cover, plug the connector and position the cable in the slit.



Close the protection cover and fasten it firmly.

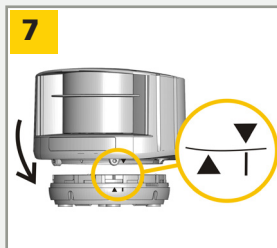

Position the housing on the bracket.

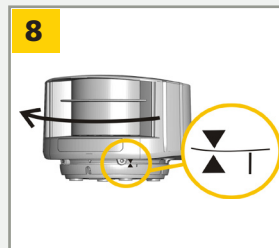

Turn the sensor until the two triangles are face to face.

2 WIRING

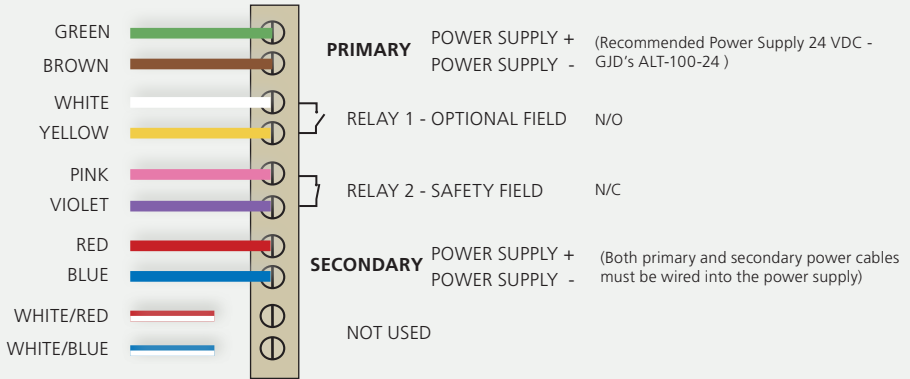

3 POSITIONING



Unlock the sensor and activate the visible laser beams.

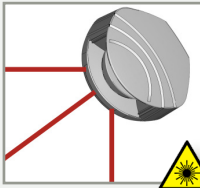

The visible laser beams indicate approximately the position of curtain C1 and limit the angle of the detection field.

The visible laser beams stay activated for 15 minutes or can be turned off the same way they were activated.

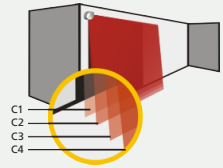

Adjust the **lateral position** of the detection field.

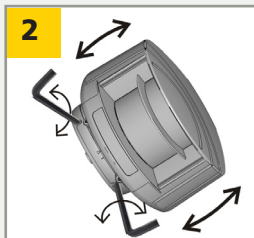

Adjust the **tilt angle** of the detection field with the hex key.

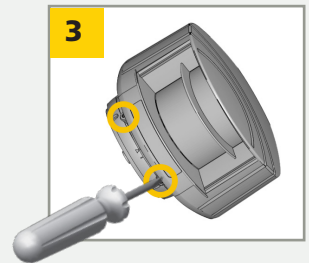

Lock the position of the mounting bracket to avoid malfunctioning in case of extreme vibrations.

CAT 2

CAUTION!

The distance between the inner curtains of the 2 sensors must be max. 20 cm.

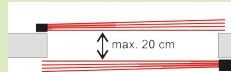

4 MOUNTING SIDE

Stay outside of the detection field to avoid disturbances.

Select the corresponding mounting side.

The sensor learns its environment and automatically determines the detection field(s).

Both RED LEDs flash slowly and the 3 visible laser beams automatically light up during 30 seconds.



«□»

1

2

CAT 2

3

4

5

CAT 2

left

right

left

right

centre

WITH BACKGROUND

The sensor memorizes the floor as reference point and signals a fault when its orientation is changed.

WITHOUT BACKGROUND

No reference point, no signal.

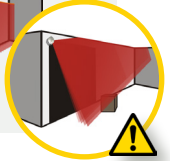
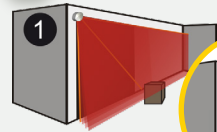

5 SAFETY FIELD DIMENSIONS



WIDTH

C□

D-TECT Laser 509

MIN MAX

0 5 - 9 9

0.5 m 9.9 m

5.0 m

D-TECT Laser 505

MIN MAX

0 5 - 5 0

0.5 m 5.0 m

HEIGHT

D□

0 0 0 5 - 9 9

no field 0.5 m 9.9 m

5.0 m

0 0 0 5 - 5 0

no field 0.5 m 5.0 m

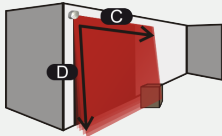

EXAMPLE



C□ - 6 2

for a field width of 6.2 m

IMPORTANT: Test the good functioning of the installation before leaving the premises.

TEACH-IN

Launch a teach-in after changing the sensor position or when new objects are added to or changed in the detection zone.

The detection field should be free of snow buildups, heavy rain, snowfall, fog or other moving objects.



Wait for the sensor to learn its environment or lock it by remote control.

During teach-in, the sensor learns its surroundings and adapts the detection field shape to these. Objects in the detection field will be cut out.

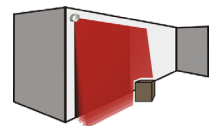

REMOTE CONTROL ADJUSTMENTS

DETECTION CURTAINS

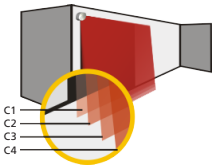

CURTAIN C1 C2 C3 C4

- 0 deactivate curtain on both fields
- 1 activate curtain only on optional field
- 2 activate curtain only on safety field
- 9 activate curtain on both fields



EX: C1 + C2 active on optional field only
C3 + C4 active on safety field only



C1 active on both fields
C2+C3 active on safety field only
C4 deactivated



All curtains active on both fields

The distances between the curtains depend on the mounting height and side. When mounted on the left, the distance between the first and the last curtain is approximately 10 cm for every meter (mounting height). **Example:** at 5 m the distance is 50 cm.

UNCOVERED ZONE

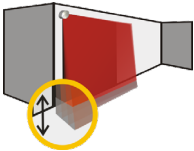

The distance from the floor upwards where a detection will not trigger the D-TECT Laser.

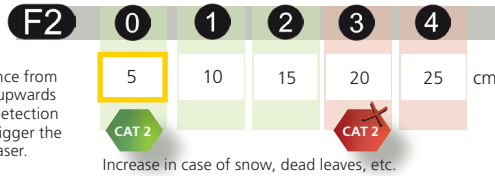

IMMUNITY FILTER

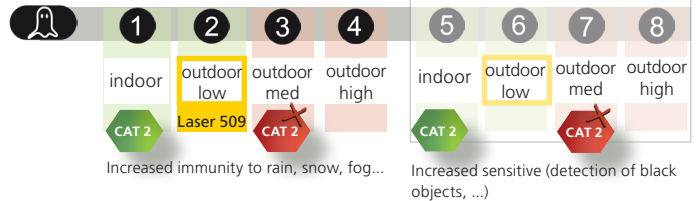

MIN. OBJECT SIZE (approximate values)



OUTPUT ACTIVATION DELAY (approximate values)



The outputs are triggered after a constant detection time of x ms (ex. value 3 = 300 ms).

DETECTION FIELD REDIRECTION

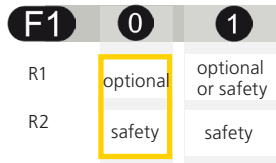

OUTPUT CONFIGURATION

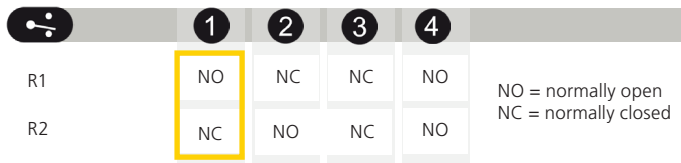
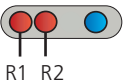

FACTORY VALUES

Rx = RELAY OUTPUT

OPTIONAL FIELD CONFIGURATIONS

Make sure the white and yellow wires are connected to the corresponding inputs before you choose one of the following two configurations.

VIRTUAL PUSH BUTTON



Install 1 or 2 virtual push buttons as activation zone(s) to open the door «manually».

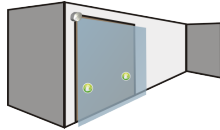

1 Apply the virtual push button sticker(s) **within the opening field.**

2 Launch a PB teach-in to configure the detection zone(s). Launch a new PB teach-in each time the sensor position is changed or new objects are added to or changed in the detection zone. **ATTENTION!** This PB teach-in is different from the safety field teach-in.

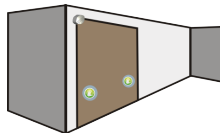

When the red LED flashes very slowly after 3 seconds, hold your hand in front of the sticker to learn the detection zone. The green LED flashes 3x to confirm the selection.

When the red LED flashes again, learn a second (max. 2) detection zone or wait until the LED switches to green.

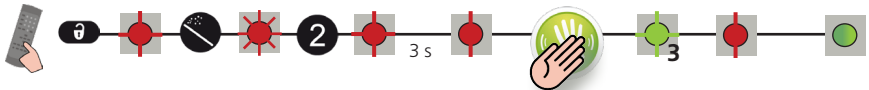

3 Change the output redirection if needed.

In order to cancel the virtual push button function, you have to launch a new PB teach-in without any movement in the detection field. Only then the safety-during-opening can be configured.

OR SAFETY-DURING-OPENING



Configure a second detection field to secure the door during opening.

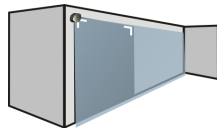

1 After setting the mounting side, the safety and the optional field will have the same dimensions.

2 Adjust the size of the field by remote control.

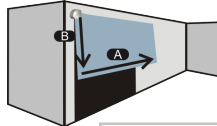

3 Change the output redirection if needed.

		D-TECT Laser 509			D-TECT Laser 505						
WIDTH	A	00	05 - 99	same as safety field	0.5 m	9.9 m	00	05 - 50	same as safety field	0.5 m	5.0 m
	B	00	05 - 99	no field	0.5 m	9.9 m	00	05 - 50	no field	0.5 m	5.0 m
HEIGHT	A	00	05 - 99	no field	0.5 m	9.9 m	00	05 - 50	no field	0.5 m	5.0 m
	B	00	05 - 99	no field	0.5 m	9.9 m	00	05 - 50	no field	0.5 m	5.0 m

HOW TO USE THE REMOTE CONTROL



After unlocking, the red LED flashes and the sensor can be adjusted by remote control.



If the red LED flashes quickly after unlocking, you need to enter an access code from 1 to 4 digits.



To end an adjustment session, always lock the sensor.

ADJUSTING ONE OR MORE PARAMETERS



CHECKING A VALUE

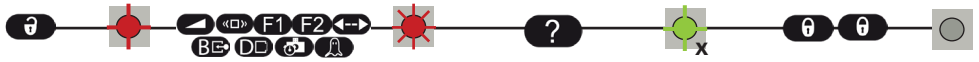

= field width: 4.2 m

= field width is defined by teach-in

RESTORING TO FACTORY VALUES



SAVING AN ACCESS CODE

The access code is recommended for sensors installed close to each other.



DELETING AN ACCESS CODE



Enter the existing code

30 minutes after last use, the sensor locks the access to the remote control session. Cut and restore power supply. The remote control session is accessible again during 30 minutes.

X = NUMBER OF FLASHES = VALUE OF THE PARAMETER

TROUBLESHOOTING

	<p>No blue LED</p>	<p>There is no power.</p> <p>The polarity of the power supply is inverted.</p> <p>All LEDs have been deactivated by remote control.</p>	<p>1 Check cable and connexion.</p> <p>1 Check the polarity of the power supply.</p> <p>1 Activate the LEDs by remote control.</p>
	<p>Only the blue LED is on.</p>	<p>The test input is not connected.</p>	<p>1 Check wiring. The RED and BLUE cable have to be connected to the test input or the power supply.</p>
	<p>The detection LED remains green.</p>	<p>The detection field is too small or deactivated.</p>	<p>1 Check the size of the fields. 2 Launch a teach-in.</p>
	<p>The detection LED remains red.</p>	<p>The object size is too small.</p>	<p>1 Decrease the min. object size.</p>
	<p>The detection LED remains red.</p>	<p>Someone or something is in the detection field.</p>	<p>1 Step out of the field and/or remove the any object(s) from the field.</p>
	<p>The detection LED remains red.</p>	<p>The field is touching the floor, the wall or the door, which leads to detection.</p>	<p>1 Activate the 3 red beams and check if the position of the sensor is correct. If not, adjust the hex screws. 2 Verify the field size. 3 Launch a teach-in.</p>
	<p>The orange LED is flashing and the detection LEDs are red.</p>	<p>No background (reference point) is found.</p>	<p>1 Check the position of the sensor. 2 Check the mounting side setting. If there is no background, set the mounting side to value 3 to 5. 3 Launch a new teach-in.</p>
	<p>The orange LED is flashing and the detection LEDs are red.</p>	<p>The sensor is masked.</p>	<p>1 Verify and clean the front screens with a damp cloth.</p>
	<p>The orange LED is on.</p>	<p>The power supply voltage is exceeding the acceptable limits.</p>	<p>1 Check the power supply voltage.</p>
	<p>The orange LED is on.</p>	<p>The sensor exceeds its temperature limits.</p>	<p>1 Verify the outside temperature where the sensor is installed. Eventually protect the sensor from sunlight using a cover.</p>
	<p>The orange LED is on.</p>	<p>Internal error</p>	<p>1 Wait a few seconds. If the LED remains ON, reset the power supply. If the LED turns on again, replace the sensor.</p>
	<p>The orange LED is on.</p>	<p>30 minutes after last use of the remote control, the sensor locks the access to the remote control session.</p>	<p>1 Cut and restore power supply. The remote control session is accessible again during 30 minutes.</p>
	<p>The orange LED is on.</p>	<p>The batteries in the remote control are not installed properly or dead.</p>	<p>1 Verify or replace the batteries.</p>
	<p>The orange LED is on.</p>	<p>The remote control is badly pointed.</p>	<p>1 Point the remote control towards the sensor, but with a slight angle. The RC should not be pointed in a right angle in front of the sensor.</p>
	<p>The orange LED is on.</p>	<p>A reflective object is in close proximity to the sensor.</p>	<p>1 Avoid highly reflective material in proximity to the sensor.</p>
	<p>The sensor does not respond to the remote control.</p>	<p>30 minutes after last use of the remote control, the sensor locks the access to the remote control session.</p>	<p>1 Cut and restore power supply. The remote control session is accessible again during 30 minutes.</p>
	<p>The sensor does not respond to the remote control.</p>	<p>The batteries in the remote control are not installed properly or dead.</p>	<p>1 Verify or replace the batteries.</p>
	<p>The sensor does not respond to the remote control.</p>	<p>The remote control is badly pointed.</p>	<p>1 Point the remote control towards the sensor, but with a slight angle. The RC should not be pointed in a right angle in front of the sensor.</p>
	<p>The sensor does not respond to the remote control.</p>	<p>A reflective object is in close proximity to the sensor.</p>	<p>1 Avoid highly reflective material in proximity to the sensor.</p>
	<p>The sensor does not unlock.</p>	<p>You have to enter an access code or the wrong code was entered.</p>	<p>1 Cut and restore power supply. No code is required to unlock during the first minute after powering.</p>

TECHNICAL SPECIFICATIONS

Technology:	laser scanner, time-of-flight measurement
Detection mode:	motion and presence (EN 12453 Typ. E)
Max. detection range:	D-TECT Laser 509: 10m x 10m; D-TECT Laser 505: 5.0 m x 5.0 m
Remission factor:	> 2 %
Angular resolution:	0,3516 °
Min. detected object size (typ.): (in proportion to object distance)	D-TECT Laser 509: 2,1 cm @ 3 m ; 3,5 cm @ 5 m ; 7 cm @ 10 m D-TECT Laser 505: 2,1 cm @ 3 m ; 3,5 cm @ 5 m
Testbody:	700 mm x 300 mm x 200 mm (testbody A according to EN 12445)
Emission characteristics:	
IR laser:	wavelength 905 nm; max. output pulse power 75 W (CLASS 1)
Red visible laser:	wavelength 650 nm; max. output CW power 3 mW (CLASS 3R)
Supply voltage:	24 VDC 3A Supply
Peak current at power-on:	2.625A max 80ms @ 24 VDC
Cable length:	10 m
Response time:	typ. 20 ms; max. 80 ms (+ output activation delay)
Output:	2 electronic relays (galvanic isolated - polarity free)
Max. switching voltage:	35 V DC / 24 V AC
Max. switching current:	80 mA (resistive)
Switching time:	$t_{ON}=5$ ms; $t_{OFF}=5$ ms
Output resistance:	typ 30 Ω
Voltage drop on output:	< 0.7 V @ 20 mA
Leakage current:	< 10 μ A
Input:	2 optocouplers (galvanic isolated - polarity free)
Max. contact voltage:	30 V DC (over-voltage protected)
Voltage threshold:	Log. H: >8 V DC; Log. L: <3 V DC
Response time monitoring input:	< 5 ms
LED-signal:	1 blue LED: power-on status 1 orange LED: error status 2 bi-coloured LEDs: detection/output status (green: no detection; red: detection)
Dimensions:	125 mm (D) x 93 mm (W) x 70 mm (H) (mounting bracket + 14 mm)
Material:	PC/ASA
Colour:	black or white
Mounting angles on bracket:	-45 °, 0 °, 45 °
Rotation angles on bracket:	-5 ° to +5 ° (lockable)
Tilt angles on bracket:	-3 ° to +3 °
Protection degree:	IP65
Temperature range:	-30 °C to +60 °C if powered; -10 °C to +60 °C unpowered
Humidity:	0-95 % non-condensing
Vibrations:	< 2 G
Pollution on front screens:	max. 30 %; homogenous
Expected lifetime:	20 years
Norm conformity:	2006/95/EC: LVD; 2002/95/EC: RoHS; 2004/108/EC: EMC; 2006/42/EC: MD; EN 12453:2000 chapter 5.1.1.6, chapter 5.5.1 Safety device E; EN 12978:2009; EN ISO 13849-1:2008 PL "d"/ CAT2; EN 60529:2001; IEC 60825-1:2007; EN 60950-1:2005; EN 61000-6-2:2005; EN 61000-6-3:2006; IEC 61496-1:2009; EN 61496-3:2008 ESPE Type 2; EN 62061:2005 SIL 2; DIN 18650-1:2010 Chapter 5.7.4
Certifications	

ENGINEER NOTES

w: www.gjd.co.uk ■ **t:** +44 (0) 1706 363 998 ■ **f:** +44 (0) 1706 363 991

Unit 2, Birch Business Park, Whittle Lane, Heywood, Greater Manchester, OL10 2SX, UK