

PACKAGE CONTENTS

- 1 x D-TECT Dual AM
- 1 x Drilling template for fixing holes
- 3 x 31.75mm wall plugs
- 3 x 31.75mm screws
- 2 x Spare Sliding Curtains
- 2 x Tamper Feet
- 1 x Installation manual

INTRODUCTION

A CCTV event trigger utilising two independent passive infrared detectors combined in a T05 package and a microwave sensor. Both PIR sensors and the microwave have to trigger before the detector signals an alarm. The high precision, very reliable presence detector has been designed for use within CCTV installations and will alarm if tampered by masking.

The integral dual axis tilt sensor allows 180° of pan and 45° tilt. This increases the speed of the outdoor installation and provides incredibly accurate aiming of the detection pattern. The electronics module is acrylic coated for additional component stability. It is encased in a vandal-resistant high impact zinc alloy housing with a UV stabilised translucent front cover ensuring the sensor is impervious to and unaffected by weather conditions. Additionally the combination of precision electronics, digital white light filter and double shielding eliminates false alarms from the sun and other visible light sources.

The D-TECT Dual AM design gives a neat and professional appearance with no visible indication of the orientation of the detector head, and totally hides the wiring.

QUICK INSTALLATION GUIDE

Apply supply voltage to the unit, the amber led flashes 10 times, then the blue LED flashes 3 times. The detector takes approximately 2-3 minutes to settle. The walk test led is factory set to OFF. Pressing the program button once will enable the walk test LED for 5 minutes.

THE FRONT COVER MUST BE FITTED WHEN WALK TESTING

FACTORY SETTINGS ARE:

- 1 RANGE 30 METRES
- 2 PULSE COUNT 1
- 3 LED OFF

When enabled the D-TECT Dual AM has four LED indicators.

Green - Microwave detection

Red - Both PIRs detection

Blue - Alarm output, both PIRs and microwave detection

Amber - Anti-Mask detection

ANTI-MASKING CIRCUIT

The cover must be fitted before applying power to the detector.

During the first 10 seconds after power has been connected, the amber LED flashes and the anti-masking circuit starts to self calibrate. The amber LED indicates when the detector is covered, but the relay contacts do not operate until the unit has been covered for 60 seconds.

SEQUENCE FOR CORRECT OPERATION

1. Make connection and replace cover.
2. Apply 12 volts power. Amber LED Flashes 10 times - self calibration completed.
3. Cover detector for 60 seconds. When anti-mask detection is continuous for 60 seconds the normally closed relay will open until anti-mask detection is cleared.

MOUNTING THE UNIT

- During installation the electronics must be protected against water, as trapped moisture can affect or damage the unit.

1. Using the template provided drill the wall to accept the two fixing screws, the cable entry and the tamper cup (if used). See fig 1 and 2.

Note: We recommend using the tamper cup on uneven wall surfaces.

2. Remove the cover assembly by loosening the locking screw. The cover hinges from the top and lifts out of the location slot. See fig 3.
3. Feed standard 8 core alarm cable into the cable entry; bare the wires and connect to the terminal block as shown in fig 7. Screw the unit to the wall ensuring that the tamper pin is correctly located and that the tamper microswitch is closed. See fig 4 and 5. To aid installation, two spare tamper feet are provided. One is 1mm longer and the other is 2mm longer than the tamper foot originally fitted. The tamper foot is a push fit and can be removed by carefully pulling it from the pin. See fig 2.
4. Always ensure when replacing the electronics module that the LED is facing forward so as to ensure correct alignment of the beam pattern. (Refer section titled "Multibeam Alignment & Masking").
5. When the detector has been aligned to suit the installation, replace the front cover and lock as shown. See fig 6.

CONNECTING THE UNIT

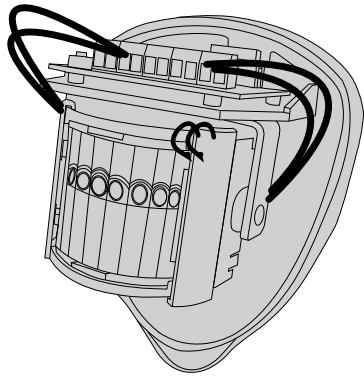
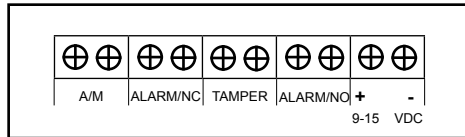

MULTIBEAM ALIGNMENT & MASKING

The GJD multifunction lens fitted to the D-TECT Dual AM detector produces 7 long range beams and 7 medium to short range curtain beams. Movement across the beams produces the best response and range for the PIRs, whilst movement towards the detector produces the best response for the microwave sensor. The unit detects the changes in heat and movement in the beam pattern, therefore items such as trees, shrubs, ponds, boiler flues and animals should be considered when positioning the detector.

The detector module is fitted with two sliding shutters to reduce the detection angle. An additional set of curtains is provided should the beam pattern need to be narrowed even further e.g. if the minimum detection angle of 10 degrees is required.

The curtains are fitted to the pan and tilt module as indicated in fig 8. Each section of the detectors lens gives a coverage pattern of around 10 degrees.

When mounting higher than boundary fences rotate the module and mask off any beams, vertically or horizontally, that fall outside the area being covered. Use portions of the self-adhesive silver mask applied to the rear, smooth side, of the lens. Always replace the lens the correct way up to ensure exact beam pattern coverage (the top of the Fresnel lens is marked - TOP). See fig 9.



When mounted at heights above 3 metres there could be a significant reduction in the range of detection and the target will have to move a greater distance within the field of view before an alarm is generated.

BEAM PATTERN

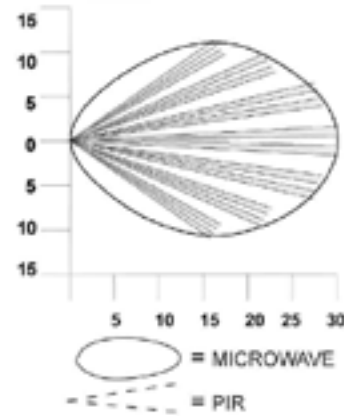

PROGRAMMING

The user can individually program a number of configurable settings as illustrated in the programming chart. Factory settings are shown as shaded boxes. Changes to the existing settings can easily be made. To reset the factory settings simply remove power from the detector, press and hold the program button (see fig 10) whilst temporarily applying power to the detector: either before installation, with a PP3 battery, or by applying 12 volts to the unit on site. The Amber LED will flash 10 times, the blue LED will flash 3 times then the blue LED will flash rapidly then release the program button.

PROGRAMMING CHART

OPTIONS	SETTING			
		1	2	3
	1	Range (m)	10	20
2	Pulse Count	1	2	
3	LED	OFF	ON	

EXAMPLE

To change the LED setting from OFF to ON.

1. Press the program button three times and release the button.
2. Wait until the indicator goes off.
3. The indicator will now flash once.
4. Press the program button twice and release the button.
5. The indicator flashes twice showing that the option has been stored and the detector returns to normal operation.

WALK TEST

The range of the detector increase without the front protective cover. Therefore the front cover must be fitted to establish the correct beam pattern alignment and when testing the outputs. Use the programming chart to adjust the range as necessary and pan and tilt the lens module over the field of view to obtain the correct coverage area.

When the 'program' button is pressed momentarily the blue indicator lights and pulse count '1' is automatically selected. The unit can then be aligned. The blue indicator will light on the D-TECT Dual AM every time a detection takes place. This test mode will automatically cancel five minutes after last detection. Alternatively, remove the power and then re-apply.

OPTION DEFINITIONS

PULSE COUNT

This is the number of times the unit has to detect on both of its sensors before signalling an output.

LED MONITOR

LED Off - LED disabled.
LED on - LEDs signal a detection.

N/OPEN & N/CLOSED

These are magnetically immune volt free relay contacts used to trigger alarm inputs on connected equipment.

The contacts are rated at a maximum of 24 AC/DC @ 50mA.

ACCESSORIES

GJD is able to supply the following accessories to aid installations:

- GJD304 Conduit cable entry adaptor ring
- GJD305 Pole mount clamp
- GJD380 Walk tester

SPECIFICATIONS

Microwave Frequency	10 dBm EIRP Operating frequency (country specific) GJD369/25 - 10.525GHz GJD369/35 - 9.35GHz GJD369/87 - 10.587GHz GJD369/41 - 10.41GHz GJD369/90 - 9.9GHz	
Detection Area	Programmable between 10 & 30m	
Coverage	10-70 degrees detection angle, 30m x 30m coverage max.	
Adjustment	180 degree pan + 45 degree tilt	
Fresnel Lens	28 zones for each Pyro pair, which can be masked with the curtain sliders	
Customised Optics	Double silicon shielded quad element eliminates 50,000 Lux of White-Light	
Microwave Module	Operating Frequency. Country dependent GHz 10 dBm EIRP	
Outputs	Silent solid state magnetically immune	
No. 1	N/OPEN	Volt free relay signal contact 24VAC/DC @ 50mA with an integral 25R series resistor Alarm time 5 seconds
No.2	N/CLOSED	Volt free relay signal contact 24VAC/DC @ 50mA with an integral 25R series resistor Alarm time 5 seconds
Power Input	9 to 15 VDC	
Current	15mA (12V nominal)	
Pulse Count	1 - 2	
Temp Compensation	Digital sensitivity adjustment	
Control	Digital microprocessor - non volatile memory	
Walk Test	Output test mode with LED indication	
Operating Temp	-20°C to +55° C Conformally coated electronics for increased stability	
Housing	High impact zinc alloy	
Protection Rating	IP65	
Dimensions	145 x 120 x 115 mm	
Weight	750grams NET, 880 grams GROSS	
Mounting Height	Variable - optimum height 3 metres	
Cable <200m	Utilising all three outputs (incl. tamper) - 8 core 7/0.2mm	
Cable <500m	Utilising all three outputs (incl. tamper) - 8 core 16/0.2mm	



SIMPLIFIED EU DECLARATION OF CONFORMITY

Hereby, GJD Manufacturing Ltd declares that the radio equipment type GJD369 D-TECT Dual AM Detector is in compliance with Directive 2014/53/EU.

The full text of the EU declaration of conformity is available at the following internet address: gjd.co.uk

Figure 1

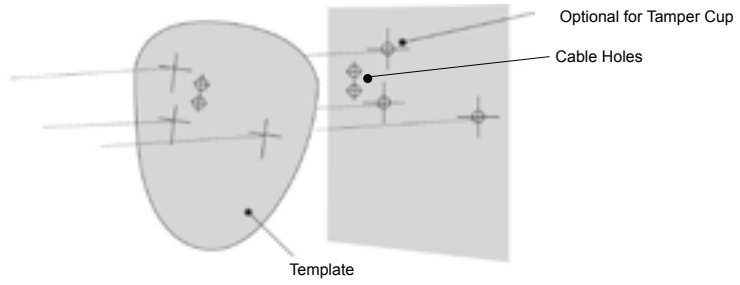

Figure 2

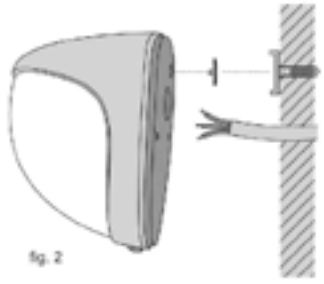

Figure 3

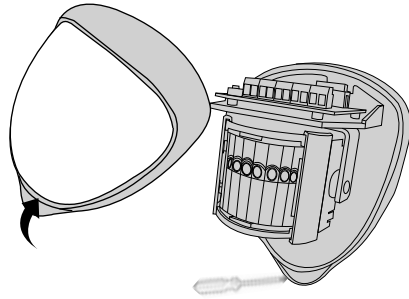

Figure 4

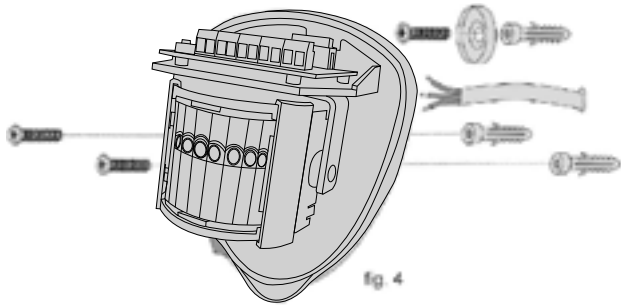

Figure 5

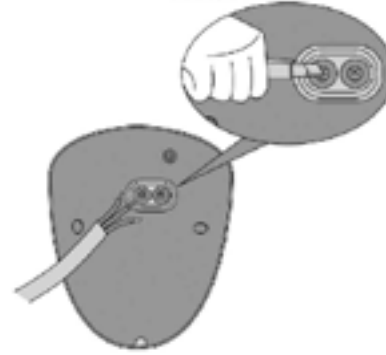

Figure 6

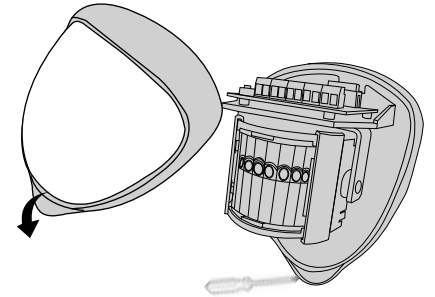

Figure 7

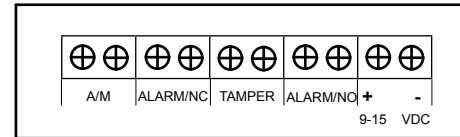

Figure 8

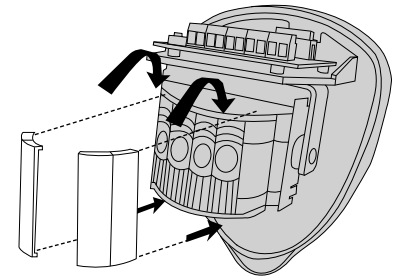

Figure 9

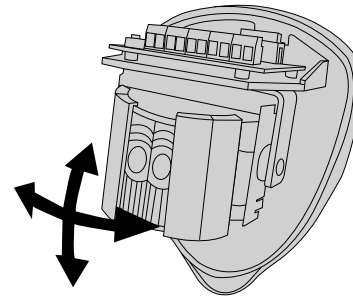

Figure 10

