

# GJD OPAL RFX WIRELESS 35 METRE EXTERNAL PIR

## INSTALLATION MANUAL

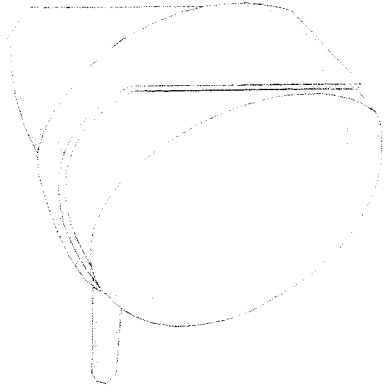

THE WIRELESS OPAL RFX EXTERNAL PASSIVE INFRARED INTRUDER DETECTOR DESIGNED TO DETECT AND TRANSMIT RELIABLE EVENT BASED TRIGGERS TO THE WEATHERPROOF RFX-3 RECEIVER. THESE COMBINED UNITS ENABLE THE SIMULTANEOUS OR INDIVIDUAL CONTROL OF CAMERAS, VCR'S, DVR'S AND VIRTUALLY ALL LOW-VOLTAGE SWITCHING REQUIREMENTS.

THE WEATHERPROOF RECEIVER WITH FRONT AND REAR TAMPER OUTPUT CAN BE POSITIONED IN LINE OF SIGHT UP TO 150 METRES AWAY. THE ACTIVE STATE OF UPTO 3 OPAL RFX PIR'S IS CONSTANTLY MONITORED. THESE SIGNALS ARE DIRECTED TO THEIR RESPECTIVE VOLT FREE OUTPUTS AND IN ADDITION THERE ARE A FURTHER EIGHT INDIVIDUAL MONITORING AND INFORMATION OUTPUTS.

---

### OPAL RFX WIRELESS P.I.R (GJD018)

#### Supply:

2 x AAA Alkaline 1.5 volt (not supplied)  
Low power typical battery life two years.

#### Transmission - 150 metres line-of-sight:

433.92 MHz frequency - SAW stabilised

#### Coverage Range 10 to 35 metres:

35 x 30 mtrs max. with 90° multifunction lens  
Internal adjustment 180° pan + 90° tilt.

#### Mounting Heights: (variable)

3 metres high for multi-beam coverage  
6 metres high for curtain coverage and  
1.5 metres for pet immunity (mask supplied)

#### Processing - Non-volatile memory:

Intelligent signal processing:  
Digital & intergral white light filter  
16 million possible identification codes

#### Adjustments:

Detection signal (CCTV) timer 0.4 to 60 secs.  
Light level signal 2 lux to daylight  
Pulse count 1 (2 & 3 ≤ 6 seconds)

Temperature: -20 C + 55 C

#### Detector Housing:

ABS high impact IP55 rated  
Weight - 152 grams  
Dimensions 110high x 100wide x 100 deep

### RFX-3 RECEIVER (GJD017)

Supply: 12VDC @ 35mA nominal  
(9 to 20VDC maximum)

#### Outputs (CCTV):

3 x independent channel outputs (24hr)  
Selectable N/O (form A) or N/C (form B)  
Individual timers 0.4 to 60 seconds after last  
detection. Non volatile memory

#### Outputs (A):

3 x independent switching -ve outputs (24hr)  
rated @ 250mA - 0.4 second on detection.

#### RF loss of signal outputs:

3 x RF/signal - ve switching rated @ 250mA

#### Lux Output (S):

1 x photocell controlled -ve switching  
Active 60 seconds after last detection

#### Tamper:

Back & Front tamper volt free output (form B)

#### Indication with outputs:

Independent channel active & low battery

Temperature: -20 C + 55C

#### Weatherproof Enclosure:

IP65 high impact ABS  
Weight - 340 grams  
183 high x 123 wide x 60mm deep

The **RFX-3 Receiver** monitors the active state of up to three Opal RFX passive infra red detectors.

The RFX-3 Receiver can be mounted externally or internally. The transmission distance of 150 metres can be obtained if the detectors are in true line of sight to the receiver. When installing the RFX-3 Receiver internally, the transmission distance of 150 metres will be reduced depending on the thickness and type of material structure the radio signals have to pass through or around.

It is advisable to conduct an RF continuity test when mounting the receiver internally to ensure that the radio signals can be received in the desired location. (RF continuity test page 5)

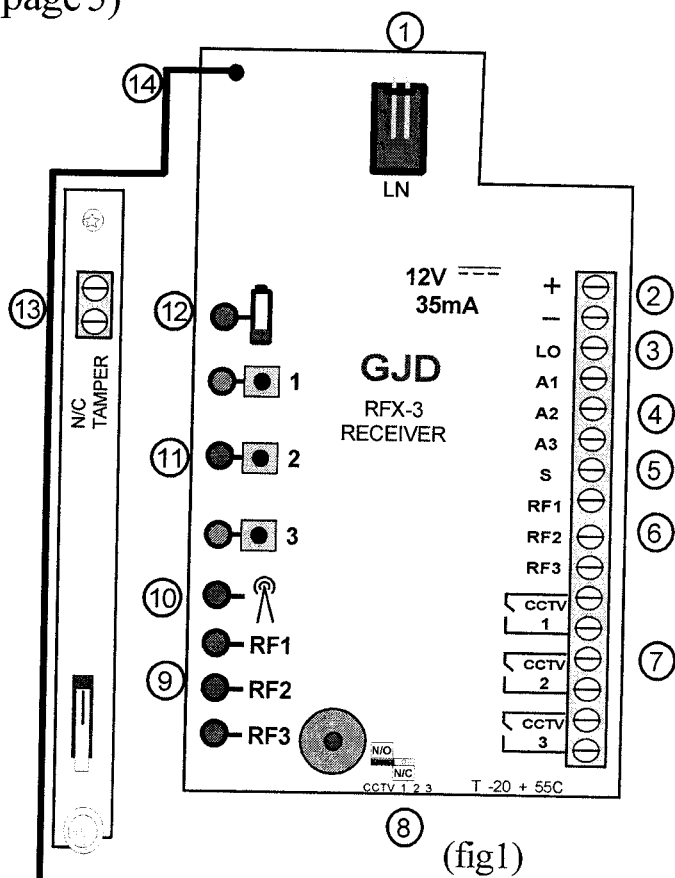

### Wireless transmission.

Each detector transmits radio signals to the receiver and has over 16.7 million individual codes. The receiver only responds to the transmitter that has been linked to a channel to identify it.

The receiver can only analyse this information after the individual code has

been transferred via the secure wire code learning link. This transfer is only required on the initial setup, any subsequent changes to the detector programming will be relayed by radio automatically to the receiver. (programming chart - page 5)

### FEATURES:

- 1) Secure wire code transfer connector
- 2) Power Supply input
- 3) LO - output pulses every 5 seconds when any batteries are low
- 4) 3 x 'A' - ve outputs which activate for 0.4 second on detection (24 hour)
- 5) 'S' output - photocell controlled
- 6) 3 x RF -loss of active signal outputs. Activates 5 mins. after not receiving a signal from a registered detector.
- 7) 3 x independent volt free CCTV contacts. Adjustable 0.4 to 60 seconds.
- 8) Selection jumper - Normally open or normally closed CCTV contacts.
- 9) 3 x RF loss of signal LED indicators
- 10) Reception - gives indication of the radio signal being received.
  - (a) Flicker = normal
  - (b) On and off indicates conflict with other radio equipment on the same frequency in close proximity.
- 11) 3 x Channel buttons  
For use in code transfer function only. Plus detection indicators that light for the length of the CCTV timer setting
- 12) Battery low indicator corresponding detection indicator will also flash every 5 seconds when battery is low (see 3)
- 13) Tamper will activate/
  - (a) when cover removed or
  - (b) displacing from the mounting point.
- 14) Aerial

## RFX-3 RECEIVER INSTALLATION

The receiver has five cable inlets which have individual moisture and insect blanking plates. There are three double and two single entry clamps for 6/8 core 5mm OD signal cables. (see fig 2)

Feed the cable from behind the unit and push into the cable guides. Ensure that the moisture and insect blanking plates are inserted in to any unused cable clamps.

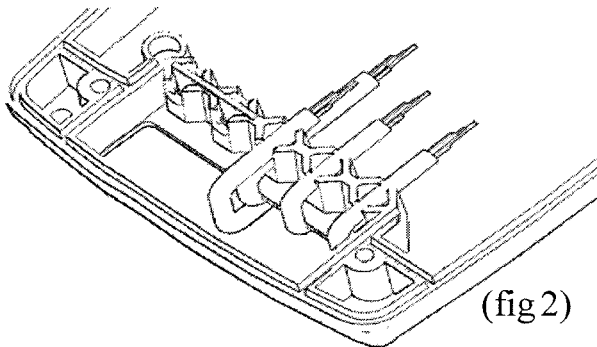

(fig 2)

## BATTERY INSTALLATION

- 1) Remove the Opal RFX cover
- 2) Remove the module from the bracket
- 3) Remove the fresnel lens
- 4) Insert 2 x AAA batteries into the module as shown. (fig 3) Put the base of the battery in first then click the '+' in firmly.

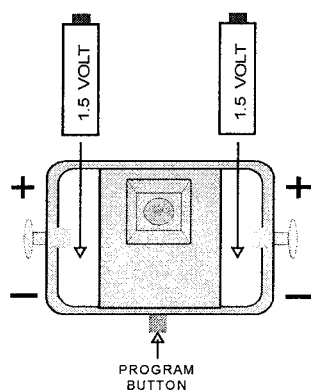

(fig 3)

To replace the batteries – push out from the holes on the reverse of the module.

## Setup

To transfer the detector code to the receiver.

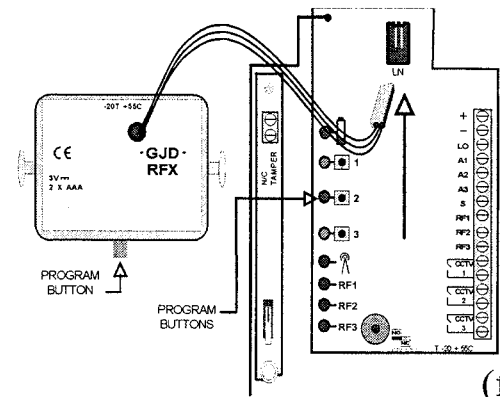

(fig 4)

- 1) Apply the 12VDC to the receiver
- 2) Plug in the link wire from the first detector in to the receiver (see fig 4)
- 3) Press the respective 'Channel button' on the receiver once – the LED lights
- 4) Within 4 seconds press the 'Program button' on the detector once
- 5) The 'Channel' indicator blinks twice. The code for that detector is stored and registered to that channel.
- 6) Remove the link wire from the receiver and plug into the aerial transmitter in the back of the detector. (see fig 5)

Detection signals will be immediately transmitted to the receiver.

(fig 5)

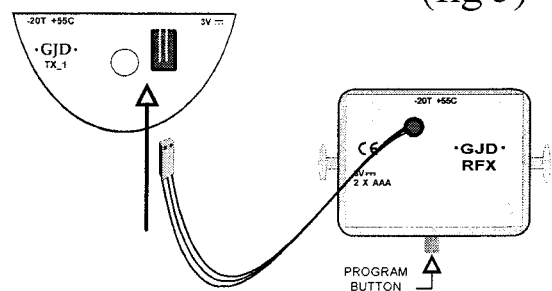

Repeat Steps 2 to 6 for each detector.

To check whether a code is stored - press the channel button once - three beeps sound.

To erase a code from the receiver - press and hold down the channel button until the continuous beeps end - then release.

# OPAL RFX DETECTOR PROGRAMMING CHART

Press

wait for indicator to go out

OPTIONS	Twice -set Range	then x	1	2	3	4	5				
		for	10	15	20	25	35	metres			
	Three -set Lux Level	then x	1	2	3	4	5	6	7	8	'S'output
		for	2	5	15	30	60	120	240	24hr	
Four -set Pulse Count	then x	1	2	3							
	for	1	2	3	pulse count						
Five -set Time 'CCTV'	then x	1	2	3	4	5	6	7	8	seconds	
	for	0.4	1	2	4	8	25	30	60		

AUXILIARY	Six	= will flashout your selected settings
	Seven	= will reset to GJD factory default settings
	Eight/hold	= will start the RF continuity test (see page 5)
	Nine/hold	= will generate and alternative random code ( see page 5)

## CUSTOMISING

All factory set parameters can be changed to suit individual requirements. The highlighted areas on the programming chart show the factory settings which suit most applications. Changes can be easily made either before installation or on site. Once changes have been made they are stored in a non-volatile memory.

## PROGRAMMING

To amend your existing 'Option' and 'Setting'

- 1) Press the program button on the detector once for the number of the required 'Option' (e.g. range-press twice)
- 2) Wait 4 seconds until the LED goes out.
- 3) Within 5 seconds press the button again for the number of the required 'Setting' (e.g 20 metres-press three times)
- 4) The LED blinks twice - the new setting is saved

To amend any other options/settings repeat steps '1' to '4'

**EXAMPLE** - To set the Range to 20 metres

- a) Press twice to select Range
- b) Wait until LED goes off (4 seconds)
- c) Press three times for 20 metres

## LUX 'S' OUTPUT ONLY:

- a) 2 lux to 240 lux. = the approximate light level at which the 'S' output is activated.
- b) 24 HOUR = will operate day and night.

All other outputs operate day and night irrespective of the 'S' output setting.

## PULSE COUNT:

The range of the unit will decrease if there is little difference in temperature between the moving object and the background.

- 1 will give a fast response
- 2 gives better immunity with good response
- 3 gives higher immunity to false activation

Timing 1 (2 & 3 ≤ 6 seconds)

## TIME 'CCTV' OUTPUT

This is the time in seconds that the 'CCTV' volt free output will activate after detection. For setup purposes the respective channel indicator will also light for this time. Adjust the jumper link on the RFX-3 Receiver to select either normally open in alarm condition or normally closed contacts.

## RF CONTINUITY TEST

It is advisable to test the RF signal at the detector location prior to installation.

To enter the RF continuity test mode - press the program button on the Opal RFX 'eight' times. On the eighth press - 'hold' the button down for 5 seconds until the LED goes out - the LED indicator will then flash and transmit one signal per second to the receiver. The corresponding channel indicator on the receiver will also flash once per second if there is a strong RF link established.

This test mode will automatically cancel in five minutes. Alternatively to cancel the 'RF continuity test - press and hold the program button until the LED lights then release.

If it is necessary to conduct a site survey prior to installation of this equipment it is advisable to power the RFX-3 Receiver temporarily with a PP3 (9volt) battery. Register one detector, then conduct an RF continuity test as detailed above. As the signals to the receiver are sent once per second the optimum position of both the Opal RFX and the RFX-3 Receiver can be easily established.

## CHANGING THE RANDOM CODE

In the unlikely event of another radio signal affecting the correct operation of a single channel. The Opal RFX detector can generate an alternative random code.

Press the program button on the Opal RFX nine times. On the ninth press 'hold' the button down for 5 seconds until the LED goes out, then release the button

Then erase the code from the RFX-3 Receiver by holding down that 'channel button' until

the beeps stop, then repeat steps '2' to '6' of the 'Setup' procedure to register the new code.

## OPAL RFX INSTALLATION:

During installation the electronics must be protected against water, as trapped moisture can effect or damage the unit.

- 1) First remove the front polythene cover by pulling forwards, then remove the lens module by pulling it out of the forked bracket.
- 2) Drill the wall to accept the fixing screw supplied with the wall plug.
- 3) Fit the housing to a secure surface. When the surface is uneven use the 4mm spacer supplied to ensure that the radio signals transmitted achieve their optimum distance.
- 4) Always ensure when replacing the module that it is the correct way up for the correct alignment of the beam pattern.  
(See page 7 Multibeam lens data)

## TESTING THE OUTPUTS

(Alignment of the detection beams)

**The range of the detector increases without the front protective cover. Therefore the front cover must be fitted to establish the correct beam pattern alignment and when testing the outputs.**

When the 'program' button is pressed momentarily the red indicator lights and pulse count '1' is automatically selected. The unit can then be aligned. The red indicator will light on the Opal RFX and the respective Channel indicator will flash every time a detection takes place. This test mode will automatically cancel five minutes after last detection. Alternatively, to cancel this 'walk test mode' press the program button twice.

## ALIGNMENT

Passive infrared movement sensors detect the temperature changes of moving objects. Movement across the beams produces the best response and range whilst movement towards the detector would be less responsive. Use the pan and tilt facility to accurately target the detection zone, and adjust the range of the detector to cover the required area.

The clear mask supplied with the detector can be cut and applied vertically or horizontally to eliminate coverage of a single beam, an entire long range section or corridor beam for CCTV applications. When mounting higher than boundary fences mask off any side beams that fall outside of the required detection area. Also ensuring that no obstacles, such as walls or large trees for example, obstruct the beam pattern view.

As the unit detects a change in heat in its field of view, therefore to avoid any false alarms, direct sunshine, trees, shrubs, ponds, central heating boiler flues and animals should all be considered when sighting the detector. The unit is not recommended for mounting on metal clad buildings in direct sun as excessive heat produces haze ripple which can produce false activation's.

Floodlights also emit haze ripple. When installing floodlights to provide movement activated lighting, position the floodlights at the side or above the detector. A minimum of 60cm (2 feet) is recommended, provided the detector is not in direct radiated heat from the floodlight.

Once alignment is completed, check that the vent hole of the front cover is positioned at the bottom. Also ensure that both sides of the outer casing are engaged before pressing the cover firmly to securely locate it.

## IMPORTANT:

Ensure the detector is mounted upright on a vertical surface. If mounting the detector on a conductive or uneven surface it is advisable to use the mounting spacer provided.

This will ensure that the aerial is above the 4mm clearance distance required from the surface to optimise the transmission range.

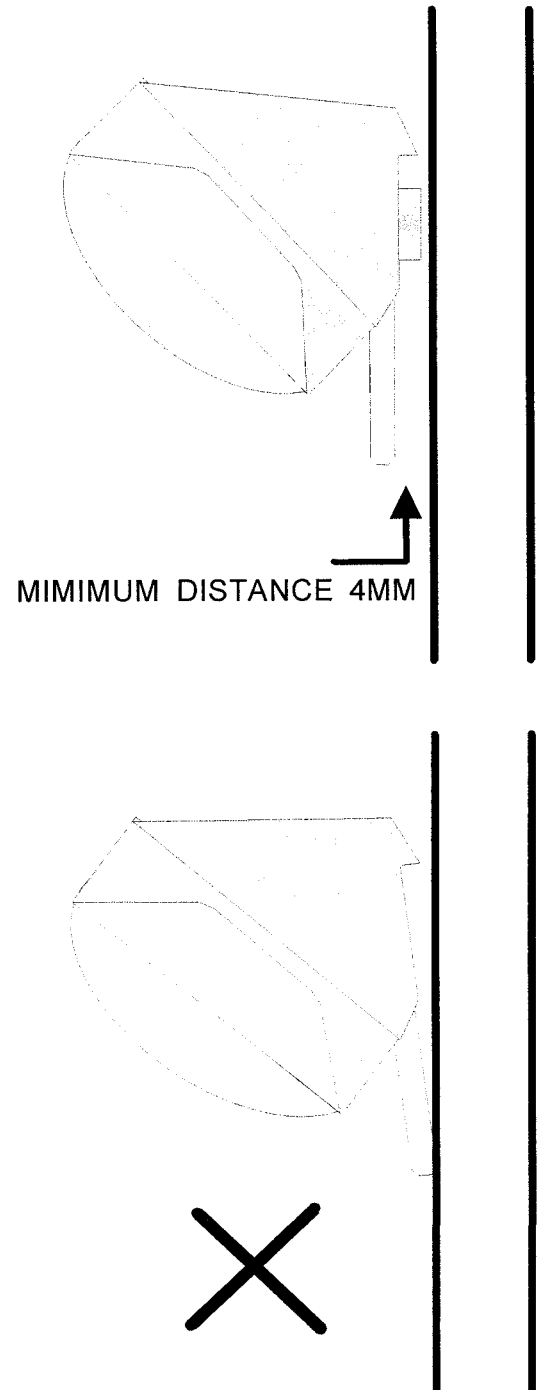

# MULTIBEAM LENS DATA

The GJD multifunction lens fitted to the OPAL RFX detector produces 9 long range beams and 9 medium to short range curtain beams. Movement across the beams produces the best response and range, whilst movement towards the detector will be less responsive.

When mounting higher than boundary fences rotate the module and mask off any beams, either vertically or horizontally, that fall outside the area being covered. Use the self-adhesive clear mask supplied to the rear, smooth side, of the lens and always replace the correct way up as shown to obtain the exact beam pattern coverage.

**MULTIBEAM - OPTIMUM**  
 HEIGHT: 3 METRES  
 RANGE: MAXIMUM  
 MODULE TILT: 0 DEGREE

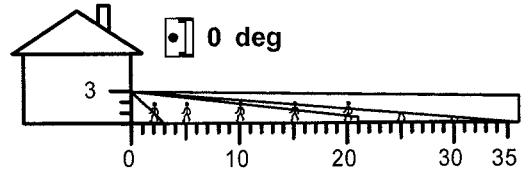
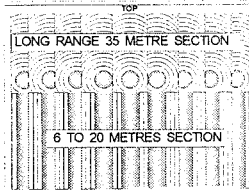

**MULTIBEAM**  
 HEIGHT: 6 METRES  
 RANGE: MAXIMUM  
 MODULE TILT: 9 DEGREE

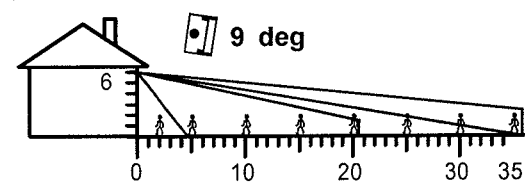
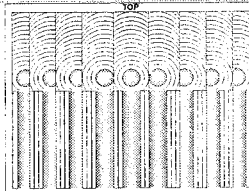

**PET IMMUNITY**  
 HEIGHT: 1.5 METRES  
 RANGE: MAXIMUM  
 MODULE TILT: -2 DEGREE

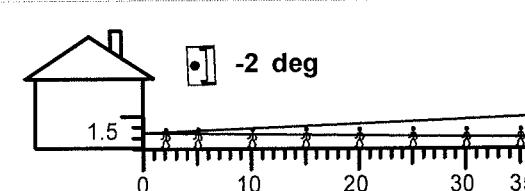
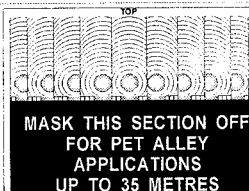

**CURTAIN COVERAGE**  
 HEIGHT: 6 METRES  
 RANGE: MAXIMUM  
 MODULE TILT: 45 DEGREE

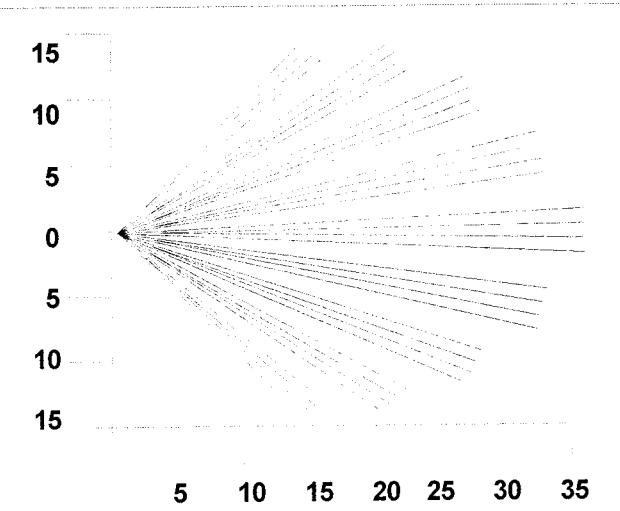
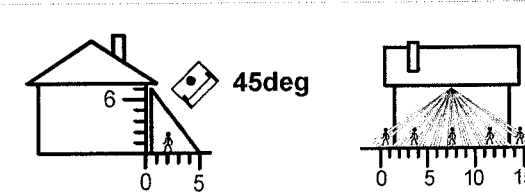

Beam Pattern set to maximum range Masking top section of lens will reduce range to 20 metres

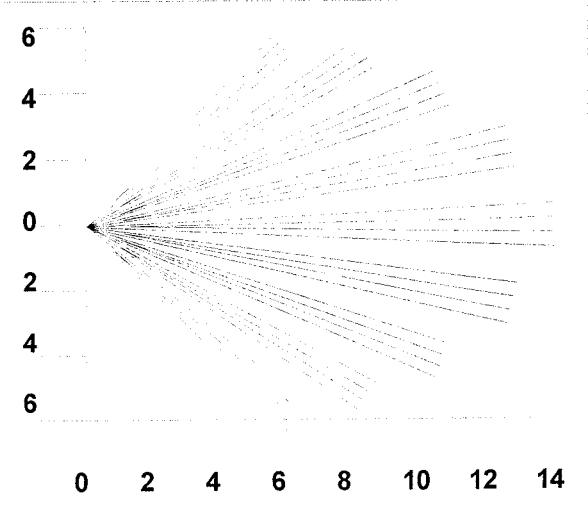

Beam Pattern set to minimum range. Masking top section of lens will reduce range to 6 metres

