

GJD SAPPHIRE MK3 LIGHTING CONTROLLER

INSTALLATION MANUAL

PART NO: GJD005

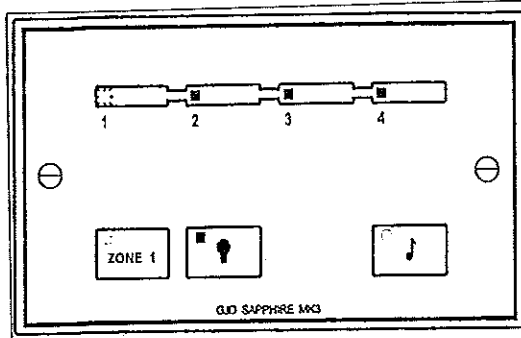

THE GJD SAPPHIRE IS A SINGLE AREA SECURITY LIGHTING CONTROLLER WHICH ENABLES EXTERNAL AREAS TO BE ACCURATELY MONITORED.

IT AUTOMATICALLY SWITCHES UP TO 1500 WATTS OF RESISTIVE LIGHTING AT NIGHT FOR A PRE-SET PERIOD AND CAN BE MANUALLY OVERRIDDEN WHEN REQUIRED. THE CONTROLLER INCORPORATES AN AUDIBLE WARNING TONE AND FEATURES FOUR DETECTOR INDICATORS WHICH ILLUMINATE WHEN ACTIVATED BY DETECTION DAY AND NIGHT.

SPECIFICATION

- SUPPLY:** 230Vac 50Hz via ELCB/MCB. -unit fused at 10A
- 12VDC@100mA:** GJD Opal XL (6mA) or Elite Detectors (10mA) Optional external 12VDC piezo sounder upto 50mA
- LOAD:** Each Sapphire Controller can switch up to 1500W of resistive load or 1000W of inductive load. The inductive load may require a "snubber" (suppressor) to manage the lamp discharge current.
- INDICATION:** Four 24 hour detector indicators which pulse during detection and are steady after detection for the duration of the light on timer setting.
- AUDIBLE:** Internal warning tone which sounds on detection day and night, and is button selectable.
- CONTROL:** Controls up to 8 x GJD detectors. Switches one area of lighting with manual override when required.
- OPTIONS:** Ability to activate lighting with remote push button.
Ability to have an auxiliary output.
Ability to activate lighting when linked to an intruder alarm panel.
- DIMENSIONS:** 146(W) x 86(H) x 56(D) mm Weight 495gm
- MOUNTING:** Indoor use only.
Mount in a clean dry location on a secure flat surface.
- TEMPERATURE:** -10 to + 55 Centigrade



Self contained - Class 2 independently mounted control.

OPERATING INSTRUCTIONS

When a detector is activated day or night the relevant detector indicator flickers and will remain on for the length of the timer setting. During darkness the lighting will be switched on automatically while the detector is receiving activation signals, and will automatically turn off after the preset timer period.

The 'Zone1' green indicator has to be selected for automatically controlled lighting on detection during darkness.

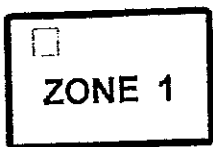

Green indicator is 'on'. This mode must be selected for automatic lighting during darkness.

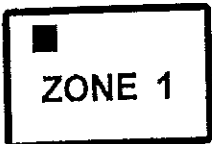

Indicator 'off'. Lighting and tone are switch off.

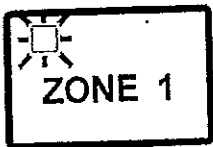

Green indicator flashing. A detector has activated the lighting.

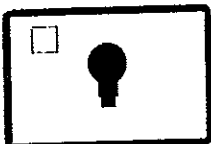

Manually selecting this yellow indicator will turn the lighting 'on'. Turning the indicator 'off' will return to automatic mode.



Indicator 'off'.

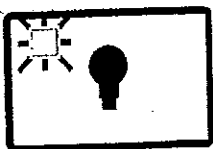

Yellow indicator flashing. A detection has automatically activated the lighting.

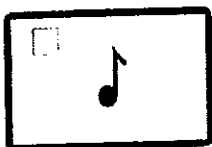

Red indicator 'on'. Audible warning tone selected. Zone 1 indicator to be selected to function.

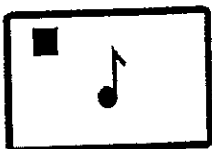

Indicator 'off' Audible warning tone is switched off.

ADJUSTMENT TO FACTORY SETTINGS:

When connecting the unit to the electrical supply or when the supply is interrupted, the indicators will flash for one minute whilst the system settles. Pressing any button during this time will start normal operation.

Internal adjustments panel

The factory settings are shown.

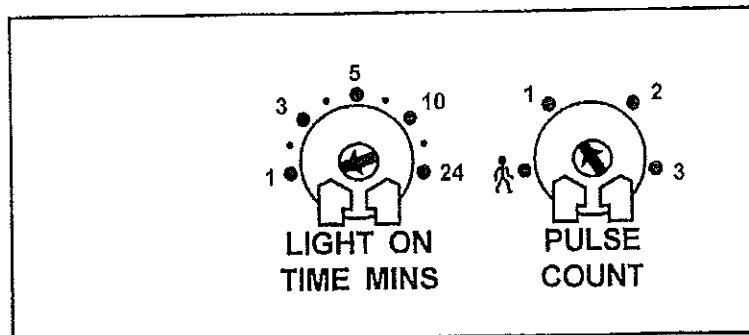

LIGHT ON TIME IN MINUTES

1 to 24
minutes

The length of the light on time after last detection during darkness. The red detector indicators will stay on for this time after the last detection day and night.

PULSE COUNT



Walk test

Select this symbol to assist in location/alignment of the detector beams during daylight installations. When the detector beams are activated the external lights will stay on for a period of 6 seconds.

1, 2 or 3

After completing the 'walk test' function, set the pulse count to the required level. The pulse count is the number of detector beams that have to be crossed to trigger the system.

- 1 will give a fast response.
- 2 gives better immunity with good response.
- 3 gives highest immunity to false activations in poor environments but is less responsive.

CAUTION: TO BE INSTALLED BY QUALIFIED PERSONNEL ONLY:

Mains voltage connections
Cable 1.5mm flat twin/earth

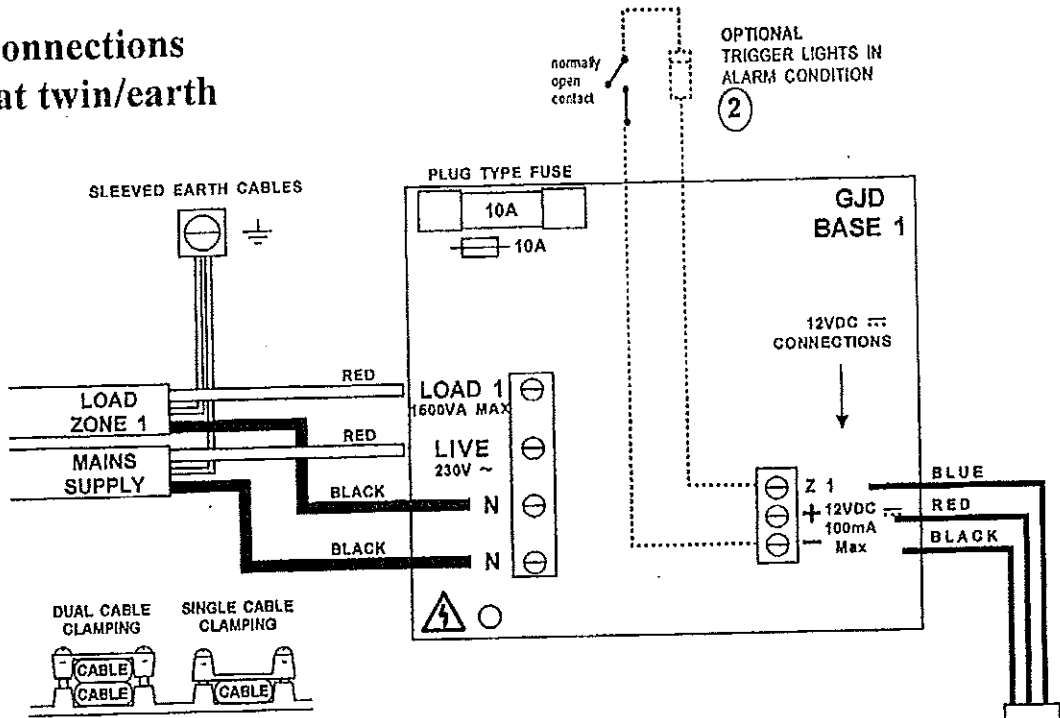

Low voltage connections
Cable 4/6 core 7/0.2mm

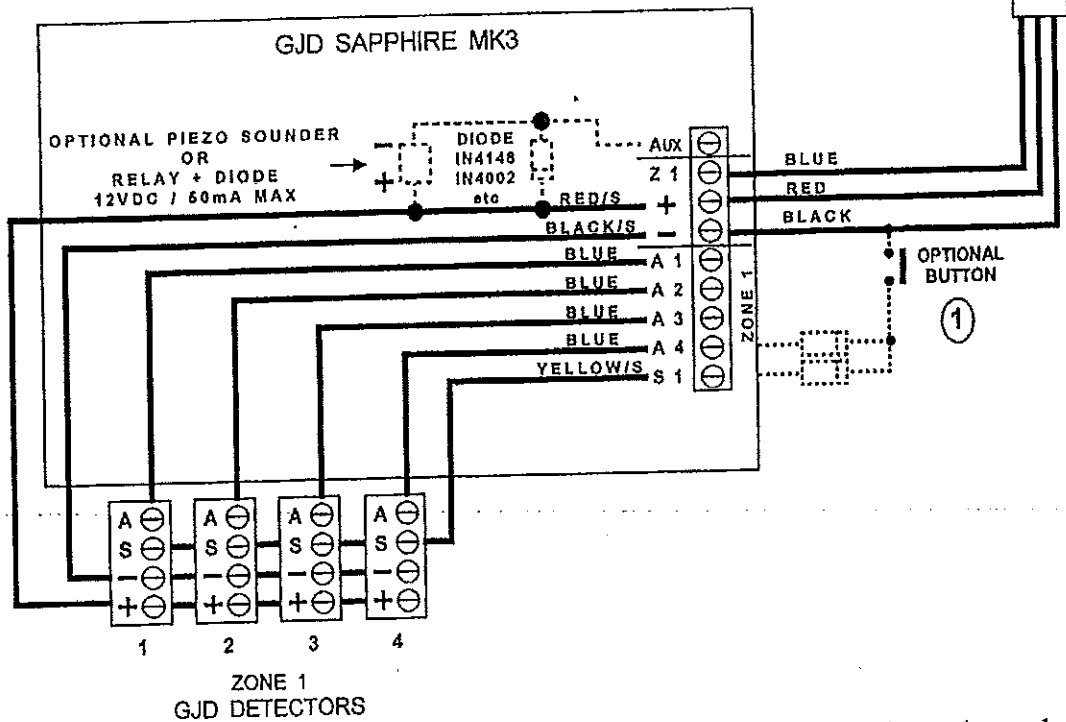

- (1) Remote triggering of lights for the timer period. Pulse Count '1' must be selected
 - (2) Activate zone lighting for alarm period when linked to an intruder alarm panel.
- All diodes: IN4148, IN4002 etc

Caution if this equipment is intended for applications not specified please contact GJD prior to installation.
 GJD Reserve the right to alter the specification without notice.

Technical: 01706 363990 Sales: 01706 363998 Fax: 01706 363991 Email: info@gjd.co.uk
 GJD Manufacturing Limited ©